

FLX Spot DVS

LED for Kitchen cabinet, Displays & Furniture

Super Slim LED Recessed Spotlight



- Linkable together with FLX series
- Single 4W diode eliminates multiple shadows
- Virtually no heat emission and no UV radiation
- Available in silver, gold, white, black
- To be used with constant voltage DC 24V driver
- Dimmable with available accessories

Various color





Various options

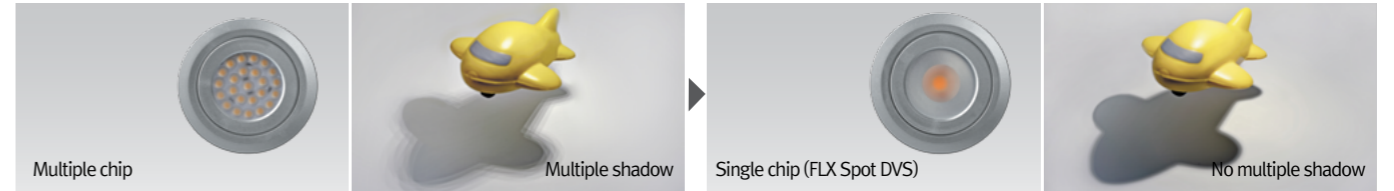

Installation

FLX Spot DVS & FLX Spot DVS

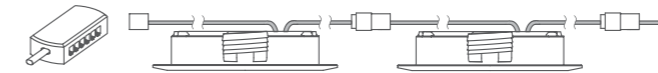

FLX Spot DVS & FLX Stix NDV

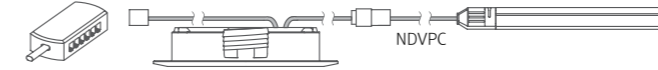

FLX Stix NDV & FLX Spot DVS

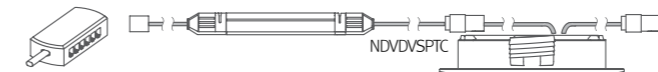

Hole Diameter

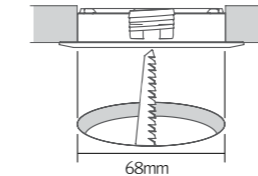

Mounting spring installation

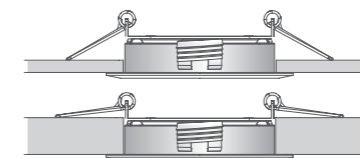

Max. connection of linked fixtures

- FLX Spot DVS : Max 7pcs in a row
- LED Driver

Model Name	Max. units for Led driver			
	24V/15W	24V/30W	24V/75W	24V/200W
DVS4A 40K-24V	3	7	17	47

Specification

Model Name	Color	Type	Power Input	Lamp Power	Luminous Flux	Efficiency	Color Rendering	Available Color	Operating Temperature
DVS4A 40K-24V-WT	White	A type	DC24V	4.3W	345 lm	80 lm/W	Ra > 85	2,700K/3,000K/3,500K/4,000K/6,000K	0-45°C
DVS4A 40K-24V-BK	Black	A type	DC24V	4.3W	345 lm	80 lm/W	Ra > 85	2,700K/3,000K/3,500K/4,000K/6,000K	0-45°C
DVS4A 40K-24V-SV	Silver	A type	DC24V	4.3W	345 lm	80 lm/W	Ra > 85	2,700K/3,000K/3,500K/4,000K/6,000K	0-45°C
DVS4A 40K-24V-GD	Gold	A type	DC24V	4.3W	345 lm	80 lm/W	Ra > 85	2,700K/3,000K/3,500K/4,000K/6,000K	0-45°C

Dimension

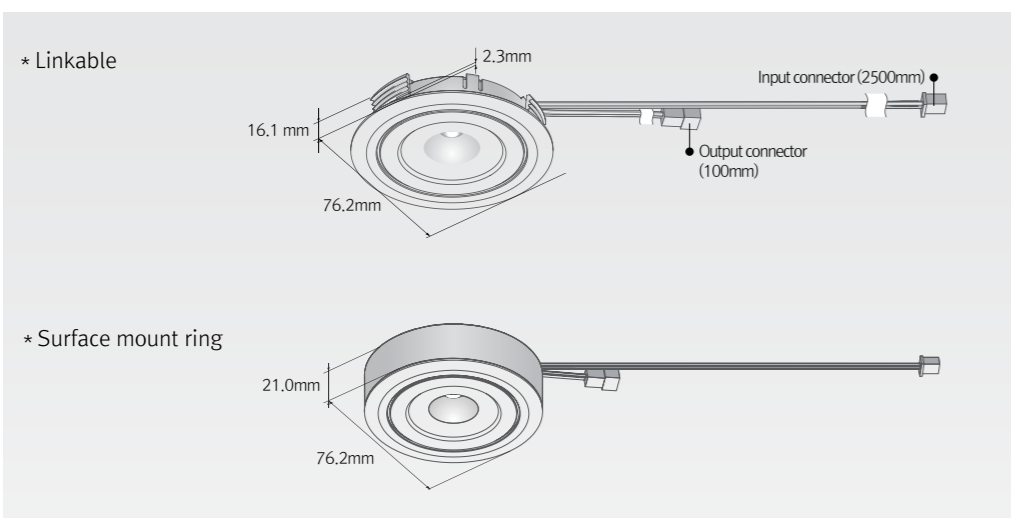

Accessories

	a) FLX Spot DVS linkable type								
	<table border="1"> <thead> <tr> <th>White</th> <th>Black</th> <th>Gold</th> <th>Silver</th> </tr> </thead> <tbody> <tr> <td>DVS4A 40K-24V-WT</td> <td>DVS4A 40K-24V-BK</td> <td>DVS4A 40K-24V-GD</td> <td>DVS4A 40K-24V-SV</td> </tr> </tbody> </table>	White	Black	Gold	Silver	DVS4A 40K-24V-WT	DVS4A 40K-24V-BK	DVS4A 40K-24V-GD	DVS4A 40K-24V-SV
	White	Black	Gold	Silver					
	DVS4A 40K-24V-WT	DVS4A 40K-24V-BK	DVS4A 40K-24V-GD	DVS4A 40K-24V-SV					
b) Extension cable : DVSPTC (2500mm) Between FLX Spot DVS & FLX Spot DVS or 6 way distributor									
c) Connecting cable : NDVDVSPTC (1000mm) Between FLX Spot DVS & FLX Stix NDV									
	d) Connecting cable : NDVPC (2500mm) Between FLX Stix NDV & FLX Spot DVS								

e) LED Driver with 12way distributor, with power cord (1,800mm)

Part No	FLC15-24V/T	FLC30-24V/T	FLC75-24V/T
Capacity	15W 24V	30W 24V	75W 24V



f) LED Driver : FLC200-24V/T (200W 24V)

LED Driver With 12way distributor



g) Dimming Interface (1-10V) : FDC-L10

Max. 100W (100W/CH, 1CH)

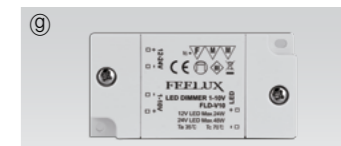

h) Dimming Interface(0-10/1-10,DMX512)

FDA-L2M0 : Max. 200W (100W/CH, 2CH)
 FDA-L5M : Max. 200W (100W/CH, 5CH)

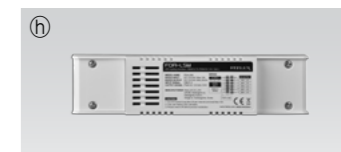

i) Mounting spring: DVS spring

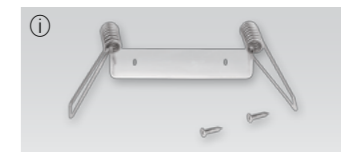

j) Mounting Spring(Back cover spring)

DVS BC SPRING



k) Surface mount ring

White	Black	Gold	Silver
DVS MR-WT	DVS MR-BK	DVS MR-GD	DVS MR-SV

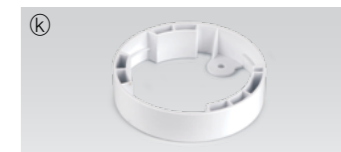

l) Deco Ring

White	Black	Gold	Silver
DVS DR-WT	DVS DR-BK	DVS DR-GD	DVS DR-SV



m) Door and motion detection sensor (DC) : FLS-M24V

Voltage : DC 24V



n) Human-body detection sensor (DC) : FLS-P24V

Voltage : DC 24V

